

MR #2023016 – BOWIE MILL ROAD BIKEWAY

Description

This is a Mandatory Referral and Water Quality Plan for the Montgomery County Department of Transportation proposal for a sidepath along approximately 3.3 miles of Bowie Mill Road between Muncaster Mill Road and Olney-Laytonsville Road, with a connection along Muncaster Mill Road to the Needwood Road Bikeway and other pedestrian and bicycle safety improvements.

NO. MR2023016

Completed: 1/10/2024

MCPB

Item No. 5

1/25/2024

2425 Reddie Drive

Floor 14

Wheaton, MD 20902

DJ	Douglas Johnsen, PLA, Planner III, Upcounty Planning Division, douglas.johnsen@montgomeryplanning.org , 301-495-4559
EG	Eli Glazier, Acting Transportation Planning Supervisor, Countywide Planning & Policy Division, eli.glazier@montgomeryplanning.org , 301-495-4548
DA	David Anspacher, Acting Chief, Countywide Planning & Policy Division, david.anspacher@montgomeryplanning.org , 301-495-2191

Summary

LOCATION

Bowie Mill Road and Muncaster Mill Road between Needwood Road and Olney-Laytonsville Road

MASTER PLAN

2018 Bicycle Master Plan

APPLICANT

Montgomery County Department of Transportation

ACCEPTANCE DATE

October 25, 2023

REVIEW BASIS

Md. Land Use Article, Section 20-301, et seq.

- Montgomery County Department of Transportation to construct a sidepath along Bowie Mill Road between Olney-Laytonsville Road and Muncaster Mill Road and along the Muncaster Mill Road between Bowie Mill Road and Needwood Road.
- The proposed project is partially within the Upper Rock Creek Special Protection Area and requires the approval of a Preliminary/Final Water Quality Plan under Section 19-62 of the Montgomery County Code, a separate action as part of this Planning Board item.
- Forest Conservation Exemption #42024017E was confirmed on October 26, 2023 as a State, County, or municipal highway construction activity per Section 22A-5(e).
- Staff recommends approval of the Mandatory Referral with comments. Staff recommends approval of the Preliminary/Final Water Quality Plan with conditions.
- The Planning Board review of a Mandatory Referral is advisory. Planning Board review of the Water Quality Plan is regulatory and binding.

CONTENTS

Section 1 – Recommendations	3
Section 2 – Project Description.....	5
Project Description.....	5
Background	6
Surrounding Neighborhood.....	7
Section 4 – Mandatory Referral Authority and Process	10
Section 5 – Mandatory Referral Analysis and Findings.....	12
Master Plan Consistency	12
Transportation Analysis.....	12
Transportation Comments	16
Environmental Analysis and Findings	24
Historic Preservation Analysis and Findings.....	24
Parks Analysis and Findings.....	25
Section 6 – Special Protection Area Water Quality Plan	31
MCDPS and MCDEP Special Protection Area Review Elements.....	31
Planning Board Special Protection Area Review Elements	31
Section 7 – Community Outreach.....	34
Section 8 – Conclusion	34
Section 9 – Attachments	34

SECTION 1 – RECOMMENDATIONS

Staff recommends the transmittal of this Mandatory Referral to Montgomery County Department of Transportation with the following comments, as expanded later in this document:

Transportation Recommendations

1. Ensure vertical obstructions, including utility poles, fences and guardrails, are at least two feet from the edge of the sidepath.
2. Provide directional curb ramps that are aligned with high-visibility marked crosswalks at all street crossings, including at Stations:
 - a. Sequoyah Elementary Bus Loop (19+50)
 - b. October Court (88+50)
 - c. Bready Road (106+00)
 - d. Cashell Road (126+00)
 - e. Brightwood Road (137+50)
 - f. Briars Road (160+00)
 - g. Olney-Laytonsville Road (174+77)
 - h. Needwood Road (201+00)
3. Explore additional protected crossing locations throughout the project area where applicable, specifically at Stations:
 - a. Bready Road – East Leg (106+00)
 - b. Brightwood Road – West Leg (137+50)
 - c. Thornhurst Drive – East and West Legs (145+00)
4. Replace missing bus pad at Sequoyah Elementary School.
5. Tighten curb radii at all intersections and driveways in line with the Complete Streets Design Guide (CSDG) default radii (15 feet). Where wider turning radii may be helpful for larger vehicles or emergency operations, consider the use of mountable curbs or relocating the receiving leg stop bar to allow for encroachment.
6. Construct raised crossings across all driveways and all locations where the sidepath crosses Neighborhood Streets and Neighborhood Yield Streets, including at Stations:
 - a. 7+00
 - b. 21+50
 - c. 35+50
 - d. 49+00
 - e. 88+50
 - f. 106+00
 - g. 137+50
 - h. 145+00
 - i. 159+50
 - j. 171+50
7. Ensure all intersections comply with Montgomery Planning’s Protected Intersection Checklist to the extent possible.
8. Smooth abrupt shifts in the sidepath alignment at Stations:
 - a. 4+50
 - b. 6+50

c. 28+00
d. 77+00

e. 85+00

9. Extend the Bowie Mill Road sidepath to the pedestrian crossing at Olney-Laytonsville Road so that it connects with the existing sidepath along the north side of Olney-Laytonsville Road.
10. Explore opportunities to provide a wider sidepath and street buffer between the sidepath and Bowie Mill Road between Briars Road and Olney-Laytonsville Road.
11. Develop a wayfinding plan using the bikeway branding signage standards.

Parks Recommendations

1. MCDOT will continue to coordinate with Montgomery Parks on the design of the sidepath and other elements including lighting, user safety elements, drainage improvements, and natural resource protection and mitigation.
2. Construction plans must be submitted to the M-NCPPC Montgomery Parks Department for review as part of the Park Construction Permit process to ensure that all work is performed in accordance with Montgomery Parks standard details, specifications, and policies. No work on parkland may occur until an approved Park Construction Permit is issued for the project.
3. Mitigation for impacts to Montgomery Parks trees (with a 6-inch DBH or greater) damaged or removed, shall either be (1) replacement planting on parkland at a rate of one inch to one inch diameter or (2) a monetary per inch caliper basis at the rate of \$100/diameter inch, to be paid to Montgomery Parks prior to completion of construction.
4. Any approved Commission parkland such as North Creek Stream Valley Unit 3 to be added to the Montgomery County Department of Transportation Road right-of-way (ROW) will be transferred to the County, as appropriate, via perpetual easement. The Commission must be paid the fair market value of the perpetual easement.
5. MCDOT and Montgomery Parks will continue to coordinate on a Memorandum of Understanding (MOU) at Bowie Mill Local Park regarding access and maintenance of the portion of the sidepath and lighting on parkland which must be agreed to and finalized before the issuance of a Park Construction Permit.

Staff recommends the approval of the Tree Save Plan and the Preliminary/Final Water Quality Plan with the following conditions:

1. The Applicant must schedule the required site inspections by M-NCPPC Forest Conservation Inspection Staff per Section 22A.00.01.10 of the Forest Conservation Regulations.
2. The Applicant must comply with all tree protection and tree save measures shown on the approved Tree Save Plan. Tree save measures not specified on the Tree Save Plan may be required by the M-NCPPC Forest Conservation Inspection Staff.
3. Before the start of any demolition, clearing, grading or construction for this project, whichever comes first, the Applicant must record an M-NCPPC approved Certificate of Compliance in an M-NCPPC approved off-site forest bank to satisfy the reforestation requirement for a total of 2.96 acres of mitigation credit. The off-site requirement may be met by making a fee-in-lieu payment, subject to Staff approval, if forest mitigation bank credits are not available at any bank.
4. The Limits of Disturbance (“LOD”) shown on the Final Sediment and Erosion Control Plan must be consistent with the LOD shown on the approved Tree Save Plan.
5. The Planning Board accepts the recommendations of the Montgomery County Department of Permitting Service (“MCDPS”) – Water Resources Section in its Combined Preliminary/Final Water Quality Plan letter dated January 22, 2020 and hereby incorporates them as conditions of the Water Quality Plan approval. The Applicant must comply with each of the recommendations as set forth in the letter, which may be amended by MCDPS – Water Resources Section provided that the amendments do not conflict with other conditions of the Water Quality Plan approval.

SECTION 2 – PROJECT DESCRIPTION

Project Description

The Montgomery County Department of Transportation (MCDOT) is designing a 3.3 mile-long sidepath along Bowie Mill Road between Muncaster Mill Road and Olney-Laytonsville Road and on the north side of Muncaster Mill Road between Bowie Mill Road and Needwood Road, shown as the solid red line in Figure 1.

Figure 1: Project Area Map

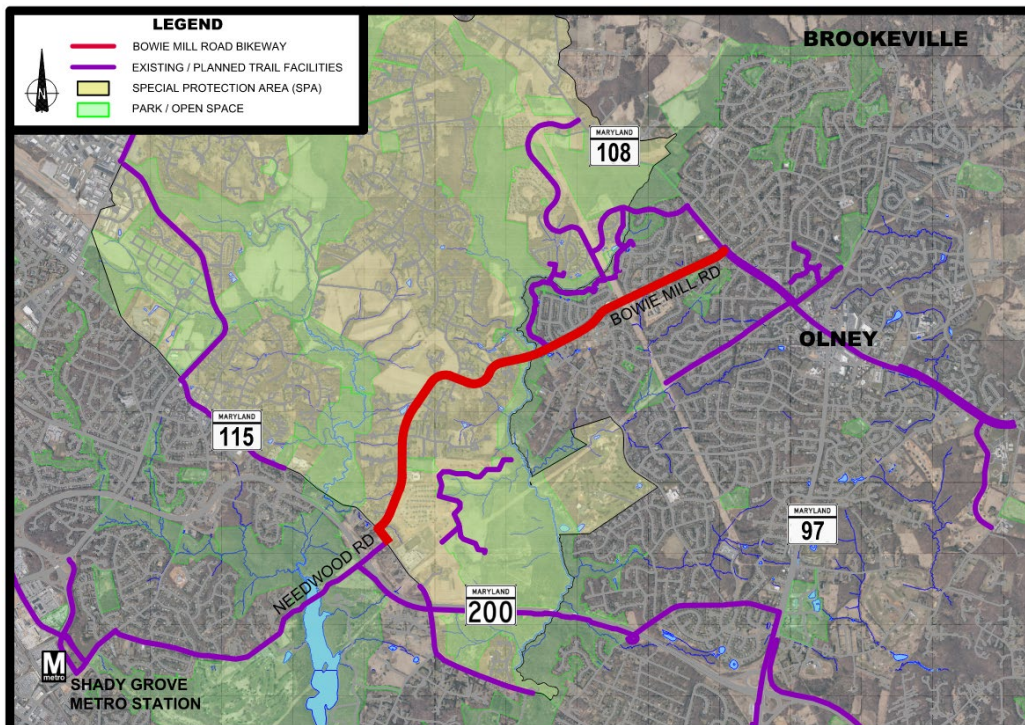

The proposed sidepath has two typical sections. Within the limits of the Upper Rock Creek Special Protection Area, the sidepath is typically eight-feet-wide with a stormwater ditch of varying width along the east side of Bowie Mill Road, as shown in Figure 2.

Figure 2: Typical Section in Special Protection Area

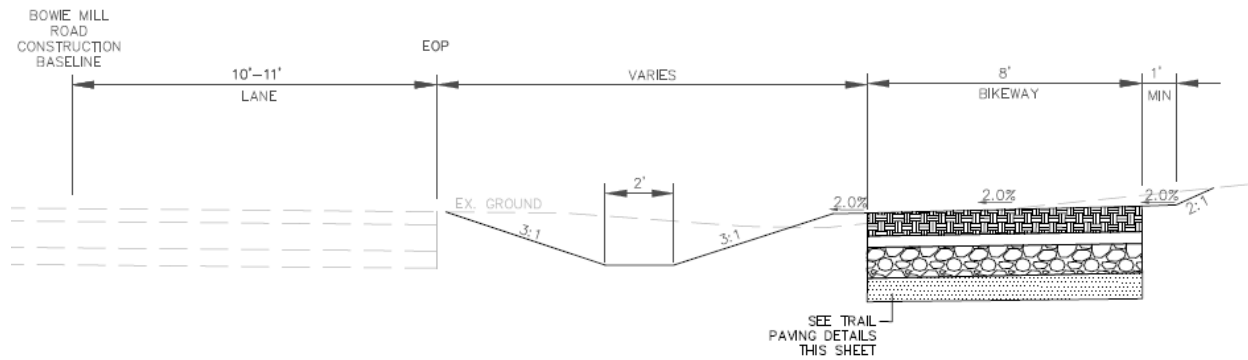

Outside the Upper Rock Creek Special Protection Area, the sidepath is typically ten-feet-wide with a stormwater ditch of varying width on the west side of Bowie Mill Road, as shown in Figure 3.

Figure 3: Typical Section outside of Special Protection Area

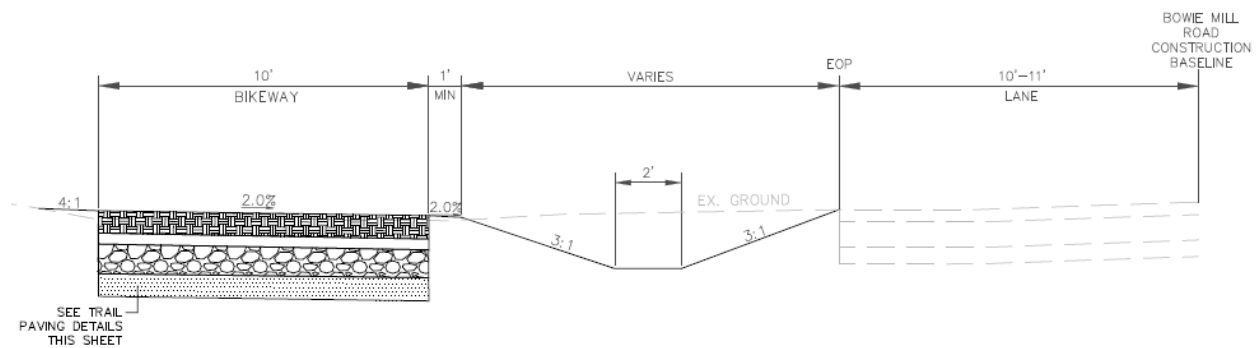

Corridor-long engineering drawings and associated cross-sections are found in Attachment A.

Background

The proposed project is recommended as a Tier 2 bikeway in the 2018 *Bicycle Master Plan*. At the northern terminus, the project connects to a sidepath along the north side of Olney-Laytonsville Road. At the southern terminus, the project connects to a sidepath along Needwood Road. In the middle, the project connects to the North Branch Trail at Bready Road. These connections and other future planned connections are shown in purple in Figure 1.

The project generally makes it easier for people to walk and bike between Derwood/Redland and Olney. It improves connectivity for people accessing the Inter-County Connector Trail and the Shady Grove Metro Station via the Needwood Road Bikeway, Sequoyah Elementary School, Colonel Zadok Magruder High School along Bowie Mill Road and Muncaster Mill Road, and Olney Town Center via Olney-Laytonsville Road.

The project is fully funded for design and construction as part of the county’s Capital Improvement Program (P502108) using a mixture of General Obligation Bonds and State Aid. Final design for the project is expected to be completed in early 2024. Construction is anticipated to begin in the following fiscal year, with an estimated 18-month construction duration.

Surrounding Neighborhood

The Bowie Mill Road Bikeway connects multiple residential neighborhoods in Olney between Muncaster Mill Road and Olney-Laytonsville Road. Zoning west of Cashell Road is typically RE-1 or RE-2, and east of Cashell Road, it is R-200. The bikeway crosses the frontage of Sequoyah Elementary School, the M-NCPPC Bowie Mill Local Park, and the M-NCPPC North Branch Stream Valley Unit Park. Part of the project is within the Upper Rock Creek Special Protection Area.

Currently, Bowie Mill Road is a two-lane, two-way roadway with twelve-foot travel lanes, inconsistent shoulder widths and occasional dedicated turn lanes (Figure 4). The 2018 *Master Plan of Highways and Transitways* provides the following roadway classifications:

- Area Connector
 - Muncaster Mill Road from Needwood Road to Bowie Mill Road
 - Bowie Mill Road from
 - Muncaster Mill Road to Sequoyah Elementary School
 - North Branch of Rock Creek to Olney-Laytonsville Road
- Country Connector
 - Bowie Mill Road from Sequoyah Elementary School to North Branch of Rock Creek

The posted speed limit is 40 miles per hour. In 2022, the Annual Average Daily Traffic along Bowie Mill Road was 10,154 vehicles between Muncaster Mill Road and Cashell Road, and 6,914 vehicles between Cashell Road and Olney-Laytonsville Road.

Figure 4: Bowie Mill Road at Dun Horse Lane



There are some sidewalks along Bowie Mill Road, but they are disconnected. Where there are sidewalks, the typical Pedestrian Level of Comfort score is Uncomfortable (PLOC 3) or Undesirable (PLOC 4) due to narrow sidewalks and street buffers adjacent to travel lanes with a 40 mile per hour speed limit. Other sidewalks along the corridor score Somewhat Comfortable (PLOC 2) where the sidewalk and street buffer widths are greater. Today, along the entire 3.3-mile-long corridor, there are four protected crossing locations: Three signalized intersections (Muncaster Mill Road at Needwood Road, Bowie Mill Road at Cashell Road, and Bowie Mill Road at Olney-Laytonsville Road) and one four-way stop-controlled intersection (Bowie Mill Road at Briars Road).

PARKLAND DESCRIPTION

The proposed sidepath construction occurs in MCDOT right-of-way (ROW) and on M-NCPPC Montgomery Parks property. The project will result in temporary and permanent impacts in Bowie Mill Local Park and North Branch Stream Valley Park Units 3 and 4 due to the proposed sidepath, which includes a bridge over North Branch Rock Creek. Bowie Mill Local Park is a 10-acre park serving the Bowie Mill Park and Bowie Mill Estates neighborhoods and is adjacent to Sequoyah Elementary School. It features playground equipment and tennis courts.

North Branch Stream Valley Park Unit 4 is 607.8 acres and North Branch Stream Valley Park Unit 3 is 402.5 acres. North Branch Stream Valley Park consists of three units with a total of 1408 acres, is predominantly forested and contains North Branch Rock Creek stream system in the Upper Rock Creek Watershed. The western portion of North Branch Stream Valley Park and the entirety of Bowie Mill Local Park fall within the Upper Rock Creek Special Protection Area. Biological monitoring data from Montgomery County Department of Environmental Protection in 2012 and 2017 indicate this portion of the North Branch of Upper Rock Creek is in good condition and the area was able to support several pollution-sensitive aquatic taxa (namely Blue Ridge Sculpin and a diversity of Mayflies (*Ephemerella* sp., *Maccaffertium* sp., and *Serratella* sp.) in 2017.

North Branch Trail in the North Branch Stream Valley consists of hard surface and natural surface sections. It makes up a significant part of the 13-mile Mid-County Loop trail system (Figure 5).

The existing road bridge and proposed sidepath bridge cross North Branch Rock Creek. North Branch is designated as a Use Class III stream which means the stream is classified as a cold-water trout stream. The Maryland Department of the Environment (MDE) enforces Time of Year Restrictions (TOYRs) for Use III streams that begin October 1st and extends until April 30th; this means no instream work can occur during the time of year restriction.

Figure 5: Vicinity Map of Proposed Bikeway and Parkland Impacts

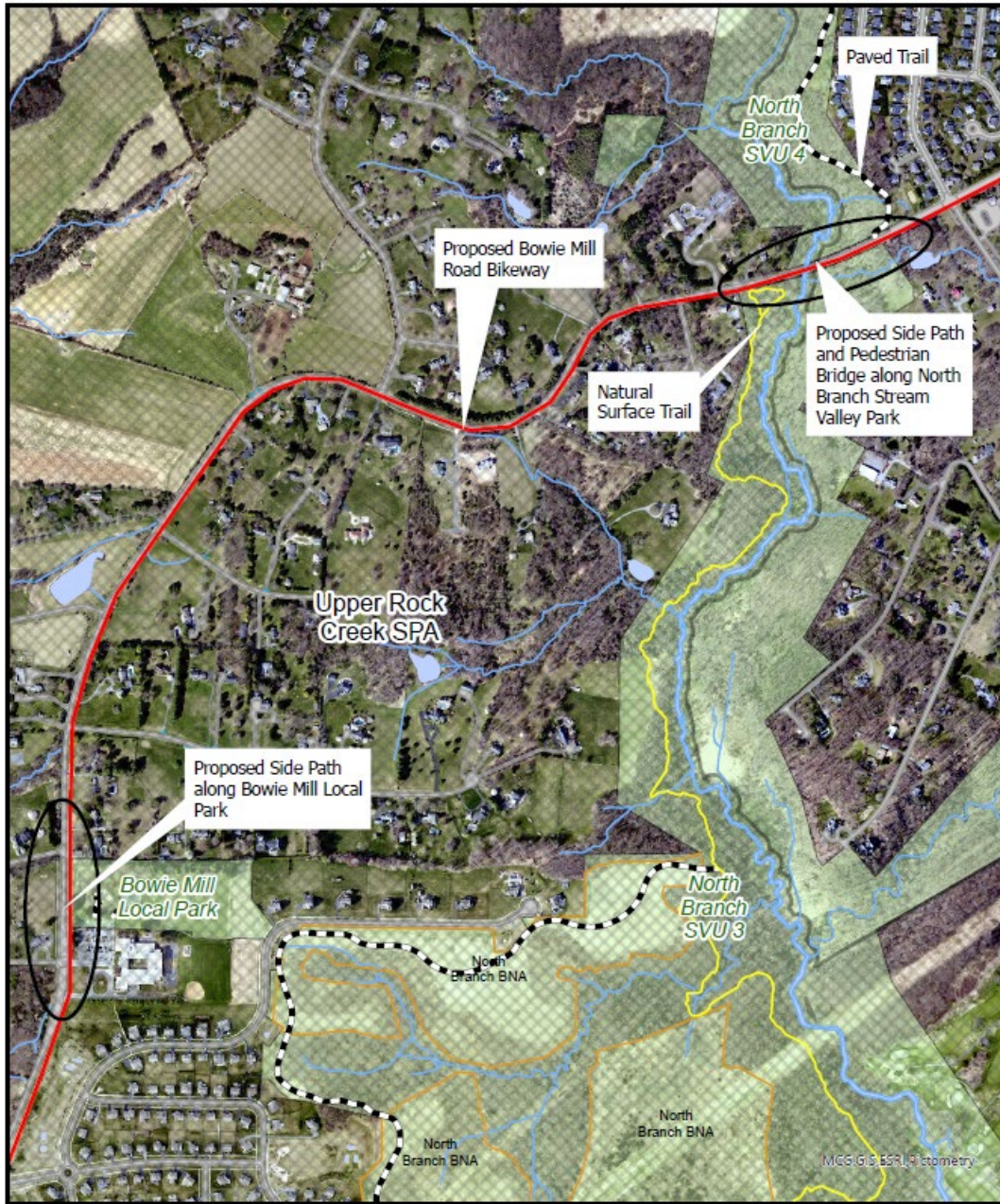

SECTION 4 – MANDATORY REFERRAL AUTHORITY AND PROCESS

Mandatory Referral review is guided by the Montgomery Planning Mandatory Referral Review Uniform Standards (December 2022), and the authority granted through the Maryland Land Use Article, Section 20-301, et.seq. As set forth in Sections 20-301 and 20-302, the Montgomery County Planning Board has jurisdiction over mandatory referral projects presented by the federal government, State of Maryland, Montgomery County government, Montgomery County Board of Education, and public utilities, among others, for:

- (1) acquiring or selling land;
- (2) locating, constructing or authorizing a road, park, public way or ground, public building or structure, or public utility; or
- (3) changing the use of or widening, narrowing, extending, relocating, vacating or abandoning any of the previously mentioned facilities.

The Planning Board must review such projects and transmit comments on the proposed location, character, grade and extent of the activity to the project applicant.

As described in the Uniform Standards, the Planning Board considers all relevant land use and planning aspects of the proposal including, but not limited to, the following:

- (1) whether the proposal is consistent with the County's General Plan, functional plans, the approved and adopted area master plan or sector plan and any associated design guidelines, and any other public plans, guidance documents, or programs for the area;
- (2) whether the proposal is consistent with the intent and the requirements of the zone in which it is located;
- (3) whether the nature of the proposed site and development, including but not limited to its size, shape, scale, height, arrangement, design of structure(s), massing, setback(s), site layout, and location(s) of parking is compatible with the surrounding neighborhood and properties;
- (4) whether the locations of buildings and structures, open spaces, landscaping, recreation facilities, and pedestrian and vehicular circulation systems are adequate, safe, and efficient;
- (5) whether the proposal has an approved NRI/FSD and a preliminary SWM Concept Plan, and meets the requirements of the Forest Conservation law (Chapters 19 and 22A of the Montgomery County Code);
- (6) whether a Preliminary or a Final Water Quality Plan has been reviewed by the Planning Board if the project is located in a Special Protection Area. In addition, for a Water Quality Plan on public property, the Board must determine if the plan meets any additional applicable standards for Special Protection Areas;
- (7) whether or not the site would be needed for park use if the proposal is for disposition of a surplus public school or other publicly-owned property; and
- (8) whether alternatives or mitigation measures have been considered for the project if the proposal is inconsistent with the General Plan or other plans and policies for the area, or has

discernible negative impacts on the surrounding neighborhood, the transportation network, the environment, historic resources (including burial sites), or other resources.

SECTION 5 – MANDATORY REFERRAL ANALYSIS AND FINDINGS

Master Plan Consistency

BICYCLE MASTER PLAN

The 2018 *Bicycle Master Plan* recommends a sidepath along Bowie Mill Road and along the segment of Muncaster Mill Road between Bowie Mill Road and Needwood Road. This is a Tier 2 bikeway in the master plan. The *Bicycle Master Plan* notes that trails and sidepaths will be a minimum of ten feet wide, although eight feet is acceptable in areas with an environmental or historic constraint. A minimum five-foot street buffer width is identified as well.

The proposed project is consistent with the master plan because the sections that are eight feet wide are within the Special Protection Area, and the rest of the project meets the ten-foot minimum width (with limited exceptions discussed later in this document). A five-foot minimum street buffer width is maintained throughout the vast majority of the corridor.

UPPER ROCK CREEK AREA MASTER PLAN

The 2004 *Upper Rock Creek Area Master Plan* notes that improvements are needed to ensure that people can safely walk, with particular attention paid to a crossing of Bowie Mill Road at Sequoyah Elementary School.

The proposed project provides improved pedestrian connections in the area but does not propose an improved crossing of Bowie Mill Road at Sequoyah Elementary School.

OLNEY MASTER PLAN

The 2005 *Olney Master Plan* includes recommendations for safety improvements to the Bowie Mill Road at North Branch Trail crossing.

The proposed project does make safety improvements at the trail crossing by rerouting the North Branch Trail to the Bready Road intersection where users can cross at a to-be-signalized intersection.

Transportation Analysis

COMPLETE STREETS DESIGN GUIDE

There are two different roadway classifications along the project corridor:

- Area Connector
 - Muncaster Mill Road from Needwood Road to Bowie Mill Road
 - Bowie Mill Road from

- Muncaster Mill Road to Sequoyah Elementary School
- North Branch of Rock Creek to Olney-Laytonsville Road
- Country Connector
 - Bowie Mill Road from Sequoyah Elementary School to North Branch of Rock Creek

Area Connectors (Figure 6) should have the following characteristics (when the current Complete Streets Design Guide is complete¹):

- Target Speed: 30 miles per hour
- Maximum Number of Vehicle Through Lanes: 2
- Maximum Protected Crossing Spacing: 600'-1,200'
- Street Buffer: six feet in curbed section, 15 feet in open section (nine feet minimum)
- Bikeway: Sidepath on one side of the street: 10 feet default, eight feet minimum

Figure 6: Neighborhood/Area Connector Cross-Section



Design Parameter	Design Guidance	Proposed by Project	Achieved by Project
Target Speed	30 miles per hour	Unchanged	No

¹ When the County Council approved changes to the Road Code in line with the Complete Streets Design Guide street classifications through Bills 24-22 and 34-22, they added a street classification called “Area Connector” that did not exist in the Complete Streets Design Guide. MCDOT and Montgomery Planning staff have been working update the Complete Streets Design Guide to provide guidance for these roads, as well as making other additions and changes. That work should be complete soon.

Maximum Number of Vehicle Through Lanes	2	Unchanged	Yes
Maximum Protected Crossing Spacing	600'-1,200'	New signal and marked crossing at Bready Road	No
Street Buffer	6' in curbed section, 15' in open section (9' minimum)	Typically 5' minimum in curbed and open section	No
Bikeway	Sidepath on one side of the street: 10' default, 8' minimum	Sidepath on one side of the street: 10' default, 8' minimum	Yes

The proposed project meets some of the default design criteria for the Area Connector, but does not meet it for maximum protected crossing spacing, target speed, or street buffer width. Over time, additional protected crossings can likely be constructed along the corridor, but a wider buffer would require the reconstruction of the proposed sidepath at a later date, which is unlikely to occur.

Country Connectors (Figure 7) should have the following characteristics:

- Target Speed: 40 miles per hour
- Maximum Number of Vehicle Through Lanes: 4
- Maximum Protected Crossing Spacing: 1,300'-2,700'
- Street Buffer: 10 feet in curbed section, 15 feet in open section (10 feet minimum)
- Bikeway: Sidepath: 10 feet default, eight feet minimum

Figure 7: Country Connector Cross-Section

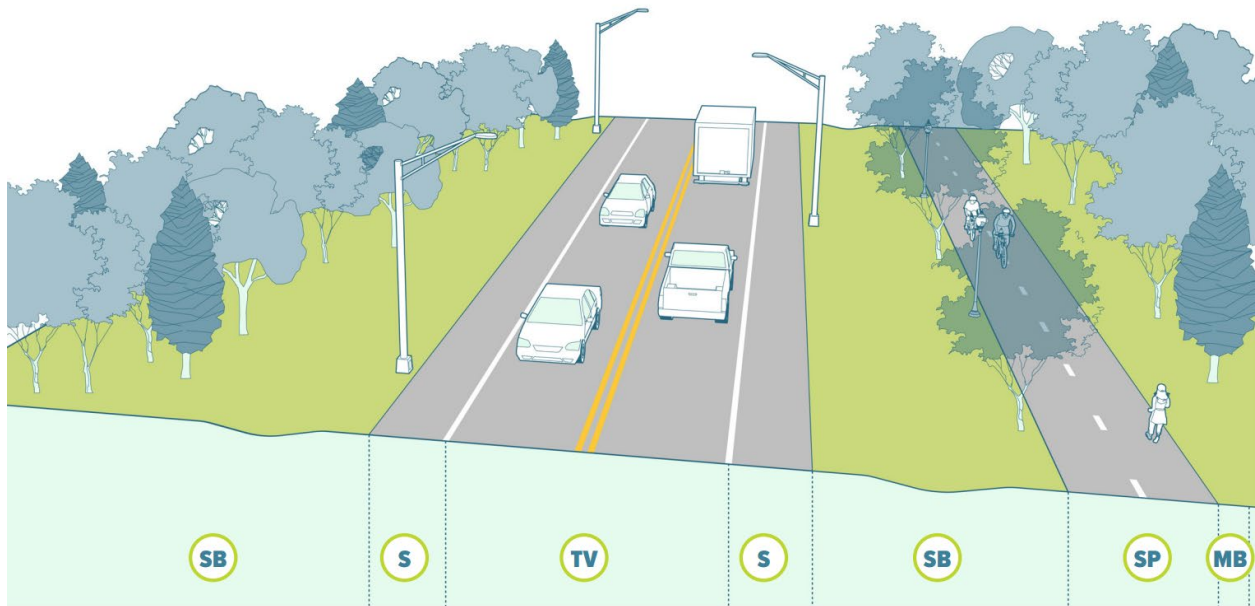

Design Parameter	Design Guidance	Proposed by Project	Achieved by Project
Target Speed	40 miles per hour	Unchanged	Yes
Maximum Number of Vehicle Through Lanes	4	Unchanged	Yes
Maximum Protected Crossing Spacing	1,300' – 2,700'	Unchanged	No
Street Buffer	10' in curbed section, 15' in open section (10' minimum)	Typically 5' minimum in curbed and open section	No
Bikeway	Sidepath on one side of the street: 10' default, 8' minimum	Sidepath on one side of the street: 10' default, 8' minimum	Yes

The proposed project meets some of the default design criteria for the Country Connector, but does not meet it for maximum protected crossing spacing or street buffer width. Over time, additional protected crossings can likely be constructed along the corridor, but a wider buffer would require the reconstruction of the proposed sidepath at a later date, which is unlikely to occur.

Transportation Comments

Recommendation: Ensure vertical obstructions, including utility poles, fences and guardrails, are at least two feet from the edge of the sidepath.

The American Association of State and Highway Transportation Officials (AASHTO) Bike Guide indicates that at least two feet of horizontal separation should be provided between any trail or sidepath and a vertical element like a utility pole, guardrail, or fence. This space, known as the “shy distance”, allows bicyclists and other sidepath users to travel comfortably along the entire pavement width without fear that they may strike an adjacent object. When vertical elements are closer than two feet from the sidepath edge, users will “shy” away from these adjacent elements, effectively narrowing the sidepath width. This is particularly an issue within the Special Protection Area where the eight-foot width with adjacent vertical elements would result in an effective width of six or seven feet – not much wider than a standard sidewalk.

Between Stations 202+00 on Muncaster Mill Road and 1+00 on Bowie Mill Road, there is a proposed guardrail immediately adjacent to the eight-foot sidepath (Figure 8). This vertical element narrows the effective width of the sidepath to six feet, which is too narrow for bicyclists to safely pass each other or to pass pedestrians. A two-foot buffer should be provided between this guardrail and the sidepath.

Figure 8: Proposed Guardrail along Muncaster Mill Road

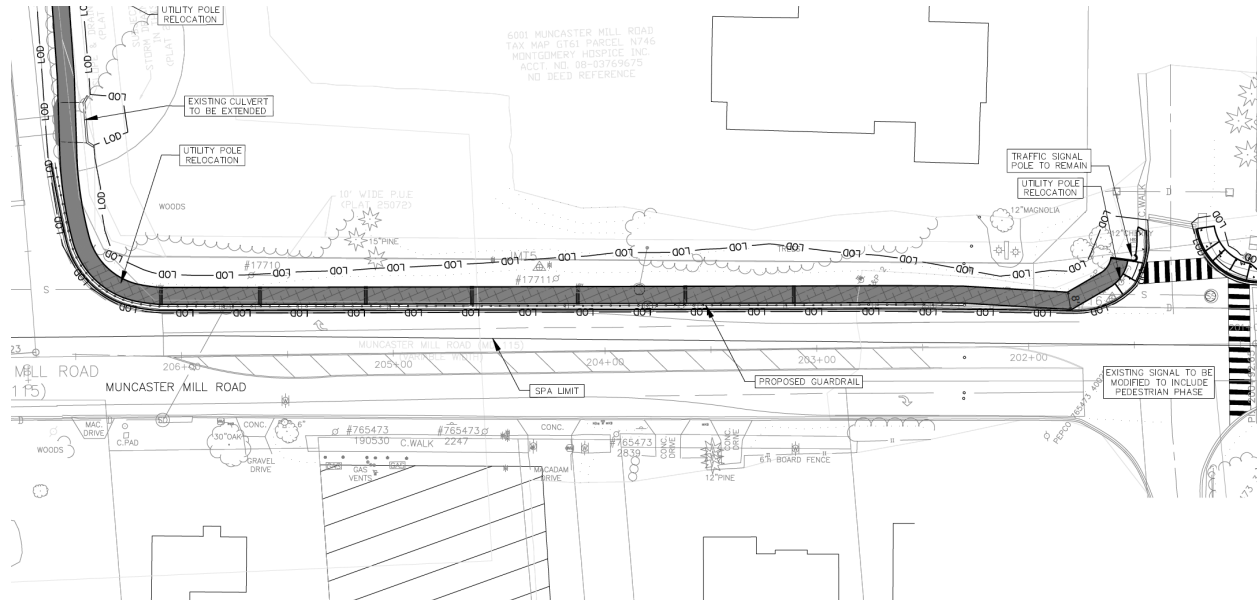

At the following Stations within the project limits, existing utility poles appear to be close to the sidepath (Figure 9):

1. 8+00
2. 10+00
3. 12+00
4. 13+50

- 5. 15+00
- 6. 17+00
- 7. 18+50
- 8. 128+00

Ensure that these utility poles are at least two feet from the sidepath. If not, consider shifting the sidepath or relocating the utility poles as appropriate to maintain the two-foot separation.

Figure 9: Example Utility Pole Locations Next to Proposed Sidepath

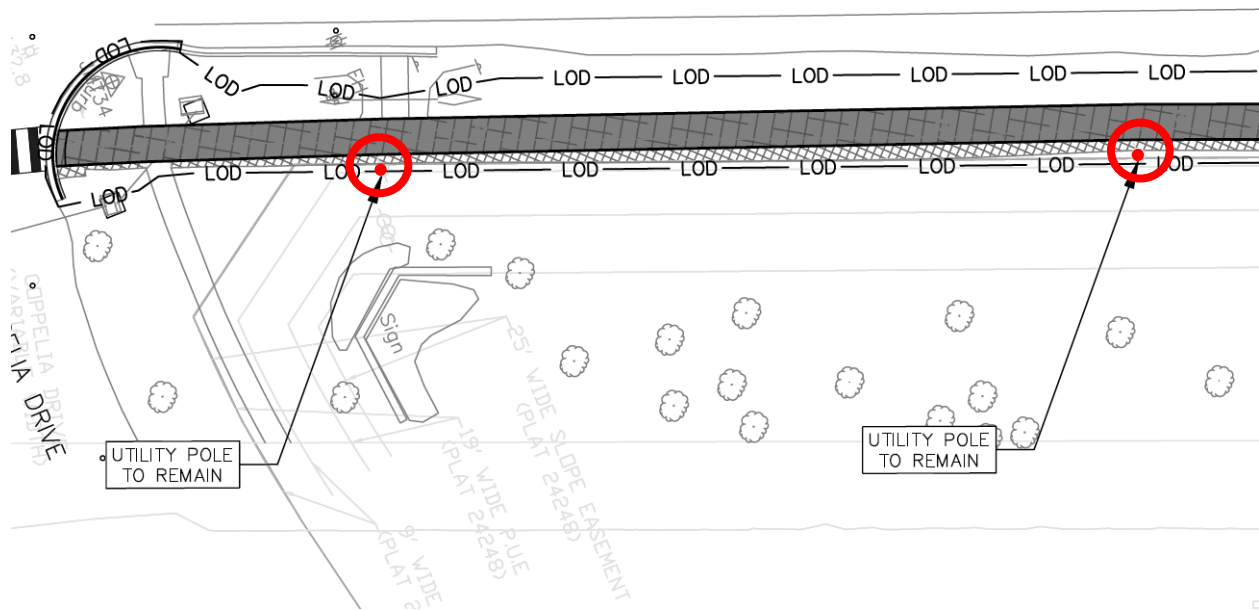

Recommendation: Provide directional curb ramps that are aligned with high-visibility marked crosswalks at all street crossings, including at Stations:

- | | | |
|--|------------------------------------|--|
| a. Sequoyah Elementary
Bus Loop (19+50) | d. Cashell Road (126+00) | g. Olney-Laytonsville Road
(174+77) |
| b. October Court (88+50) | e. Brightwood Road (137+50) | h. Needwood Road
(201+00) |
| c. Bready Road (106+00) | f. Briars Road (160+00) | |

Directional curb ramps aligned with marked crosswalks are a best practice because they guide pedestrians along the shortest path across the street or driveway, reducing pedestrian exposure to traffic. When curb ramps are oriented toward the middle of an intersection (Figure 10), people with low or no vision and those using wheelchairs or other mobility devices can be directed to cross the street outside of the intended path of travel.

Figure 10: Sidepath with Curb Ramp Concern

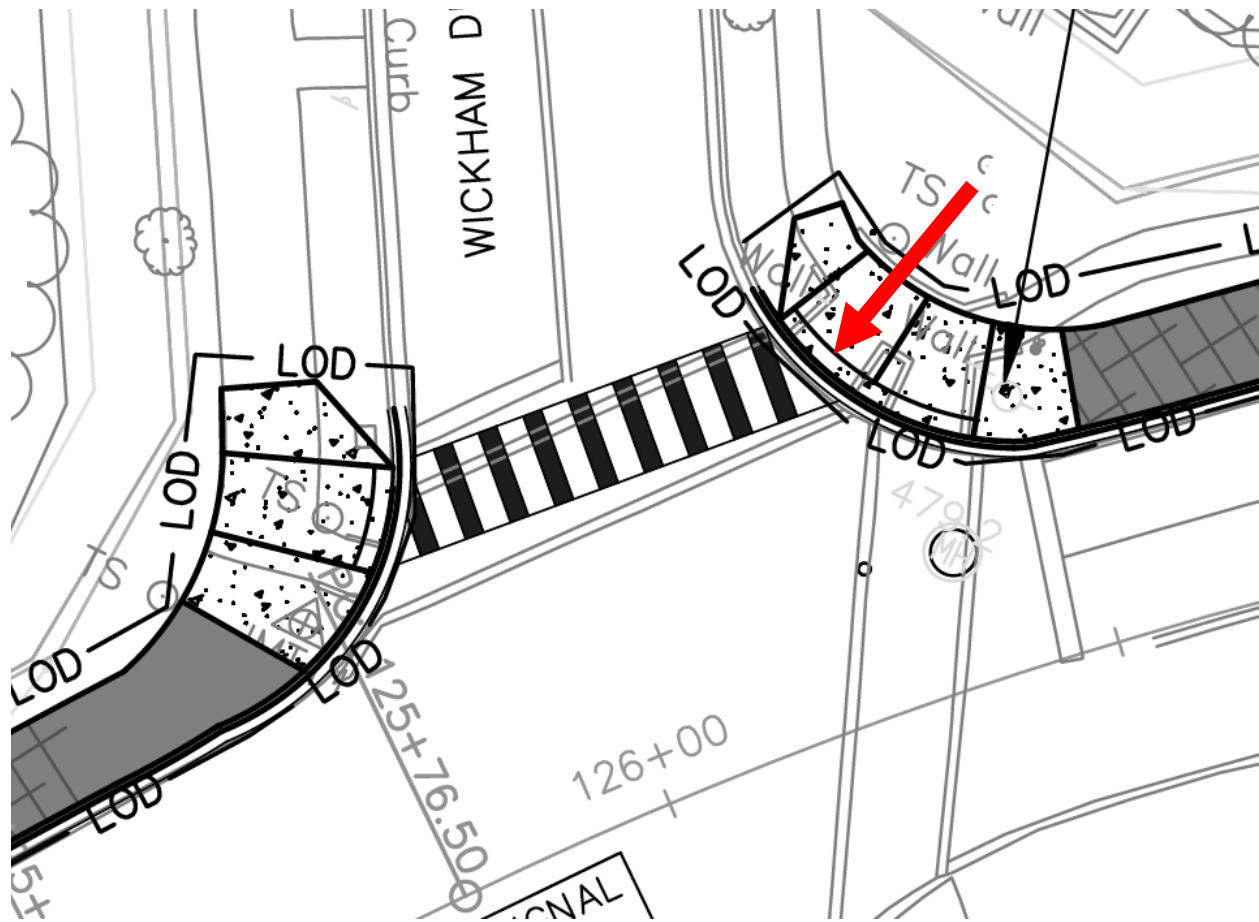

Recommendation: Explore additional protected crossing locations throughout the project area where applicable, specifically at Stations:

- a. **Bready Road – East Leg (106+00)**
- b. **Brightwood Road – West Leg (137+50)**
- c. **Thornhurst Drive – East and West Legs (145+00)**

There are three intersections within the project extent that connect to residential subdivisions on the opposite side of Bowie Mill Road from the proposed sidepath without either a connecting marked crosswalk or a protected crossing.² An example of this issue is at Thornhurst Drive (Figure 11), which lacks a protected crossing across Bowie Mill Road.

² As defined in Chapter 49 of the Montgomery County Code, a protected crossing is a location with “specific traffic control devices that improve safety and comfort of pedestrians and bicyclists crossing streets by reducing or eliminating conflicts, as well as increasing stopping and yielding for pedestrians and bicyclists, using measures such as traffic signals (full signals with pedestrian signals), pedestrian hybrid (HAWK) beacons, all-way stop control, or grade-separated crossings.”

Figure 11: Thornhurst Drive Intersection without Connection to Neighborhood to the South

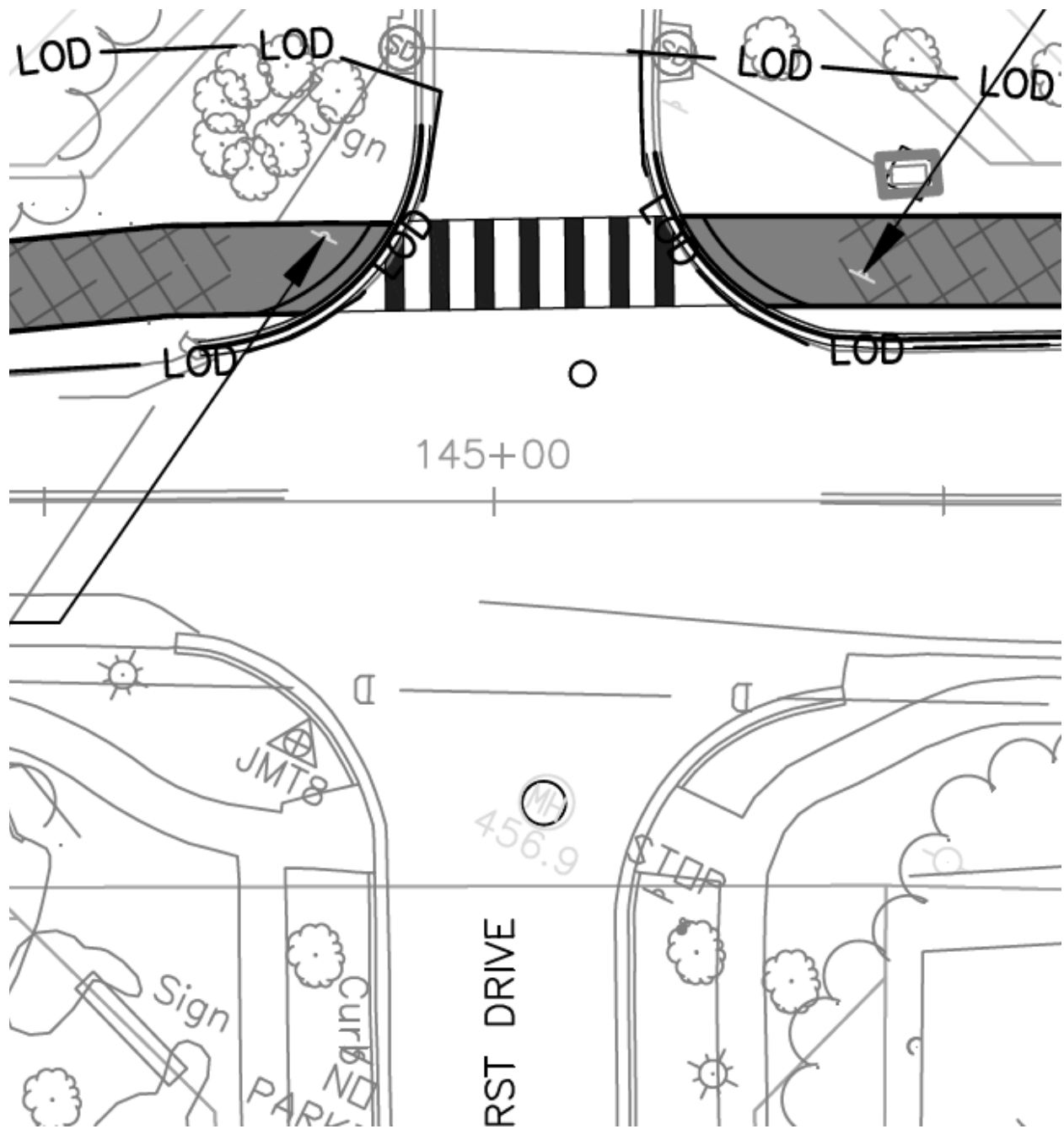

At this location and others, the project team should explore providing protected crossing features to ensure residents can safely access the sidepath and sidepath users can safely access adjacent communities.

Recommendation: Replace missing bus pad at Sequoyah Elementary School.

At the Sequoyah Elementary School bus stop (21+00), the paved pad where transit riders board and alight from buses appears to be missing. It appears in Google Streetview imagery but is shown as removed without replacement in Figure 12.

Figure 12: Missing Bus Stop at Sequoyah Elementary School

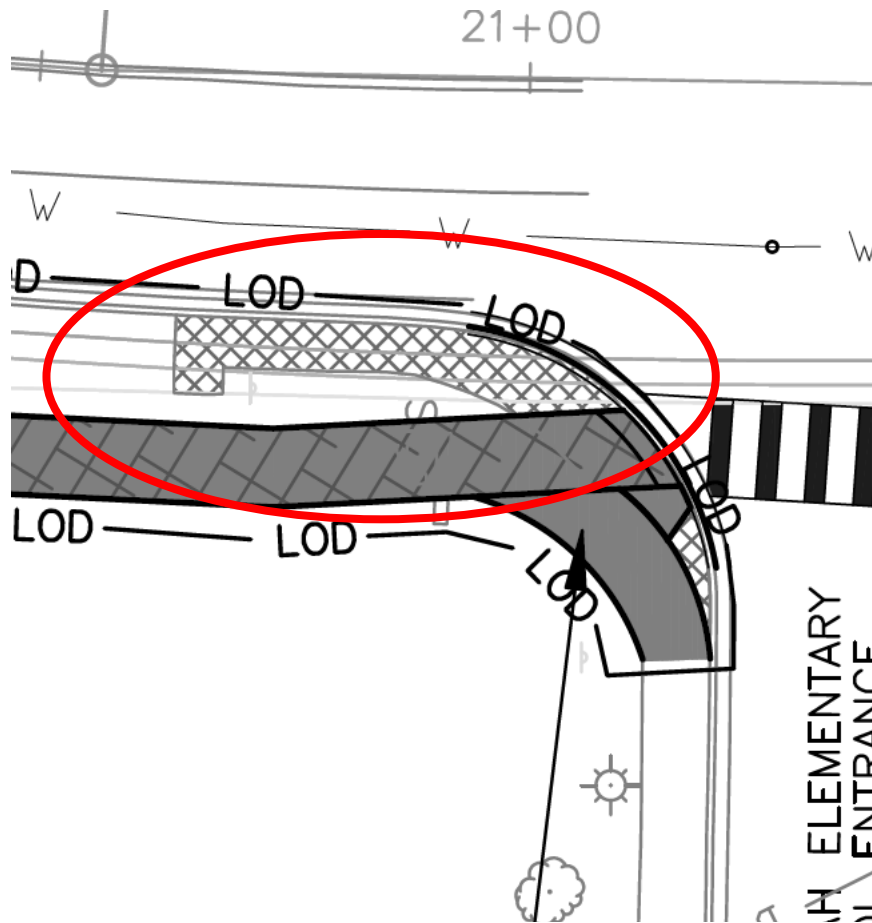

Recommendation: Tighten curb radii at all intersections and driveways in line with the Complete Streets Design Guide (CSDG) default radii (15 feet). Where wider turning radii may be helpful for larger vehicles or emergency operations, consider the use of mountable curbs or relocating the receiving leg stop bar to allow for encroachment.

Providing tight turning radii is essential to reducing the turning speed of motor vehicles, improving visibility between motorists, pedestrians, and bicyclists, and reducing the likelihood and severity of collisions between roadway users. Figure 14 illustrates how tighter turning radii improve visibility by allowing motorists to cross bikeways, sidewalks, and sidepaths at a perpendicular angle so potential conflicts can be seen through the front windshield, not over a shoulder.

Figure 13: Tighter Curb Radii Visibility Illustration

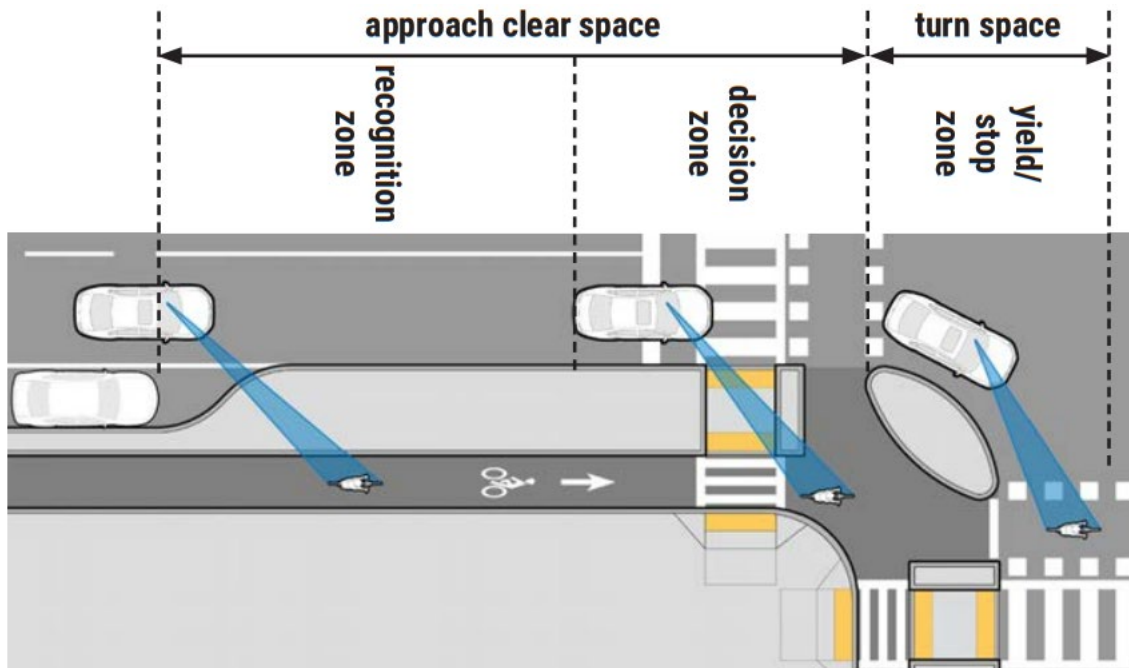

Additionally, the smaller the curb radius, the less roadway pedestrians have to cross, reducing their exposure to conflict. Figure 15 illustrates the turning radius issue at the circled corner of the intersection with Foggy Lane, but radii across the corridor should be tightened to the extent possible.

Figure 14: Bowie Mill Road at Foggy Lane

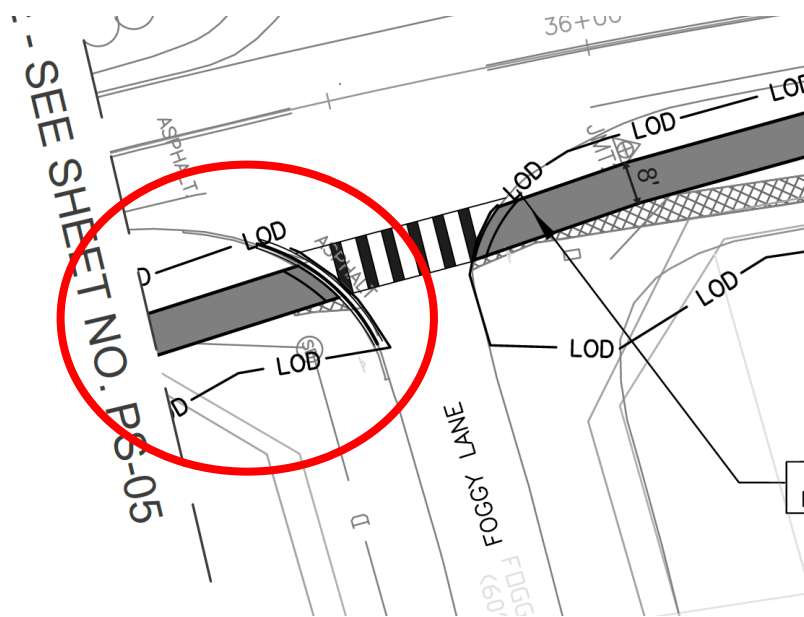

The CSDG default corner radius is 15 feet (Figure 16). The guide states that “designers should assume a maximum 10 miles per hour turning speed for passenger cars and a 5 mile per hour turning speed for all other vehicles.” Where wider turning radii may be helpful for larger vehicles or emergency operations, consider the use of mountable curbs or relocating the receiving leg stop bar to allow for encroachment.

Figure 15: Mountable Truck Apron Curb Radius (Photo: ODOT)

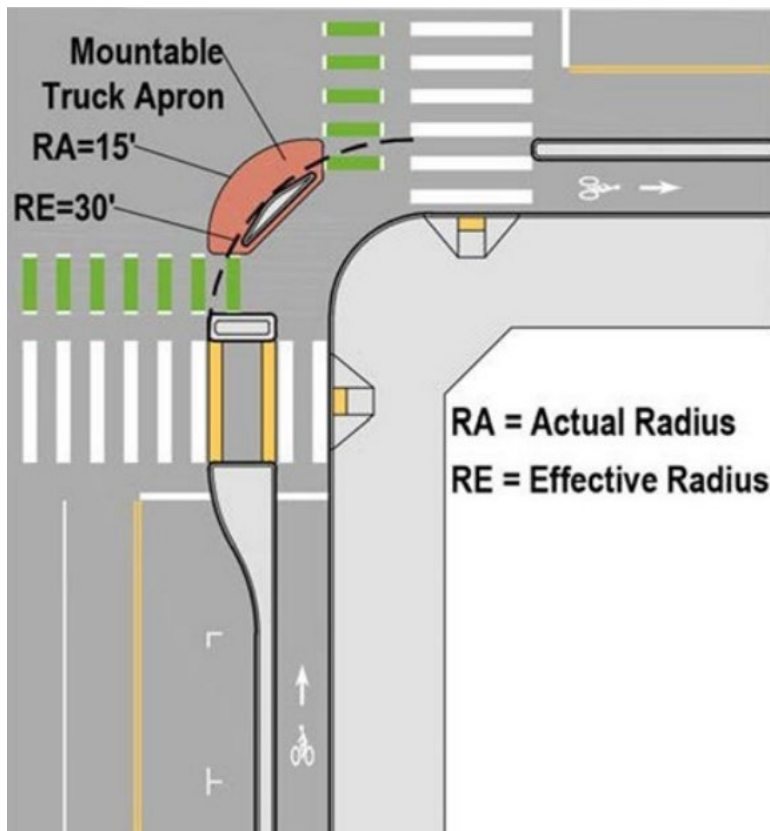

An additional benefit of tighter turning radii is that it makes it easier to provide directional curb ramps to better guide pedestrians in the crosswalk through an intersection.

Recommendation: Construct raised crossings at all intersections where the sidepath crosses Neighborhood Streets and Neighborhood Yield Streets, including at Stations:

- | | | | | | |
|----|-------|----|--------|----|--------|
| a. | 7+00 | e. | 88+50 | i. | 159+50 |
| b. | 21+50 | f. | 106+00 | j. | 171+50 |
| c. | 35+50 | g. | 137+50 | | |
| d. | 49+00 | h. | 145+00 | | |

Raised crossings slow turning vehicles, reinforce the primacy of pedestrian spaces, and create a more accessible pedestrian environment. Raised crossings (Figure 17) eliminate the need for people using wheelchairs or other mobility devices to use ramps to go down to street-level and then climb back to

sidewalk-level as they travel through intersections. This recommendation is in-line with Key Action B-3c from the 2023 *Pedestrian Master Plan*.

Figure 16: A raised crossing across a low speed, low volume street. Photo Credit: Vladimir Zlokazov



Recommendation: Ensure all intersections comply with Montgomery Planning’s Protected Intersection Checklist to the extent possible.

It is a best practice when designing sidepaths and separated bike lanes to use protected intersection treatments at applicable intersections to ensure bicyclists and pedestrians using these facilities can safely cross. These treatments should be applied at intersections in the project area. High-quality protected intersection design includes the following elements shown in Figure 18 and discussed in detail in Montgomery Planning’s Protected Intersection Checklist, which was developed in collaboration with MCDOT (Attachment B):

- 1) A *Corner Island* to physically separate the bikeway up to the intersection crossing point where potential conflicts with turning motor vehicles can be more easily controlled.
- 2) *Bicycle Queuing Space* to provide a waiting area for stopped bicyclists that is fully within the view of motorists waiting at the stop bar.
- 3) The *Clear Distance* maintains the necessary sight lines between motorists, bicyclists, and pedestrians to stop (or yield) as appropriate.
- 4) The *Motorist Yield Zone* is the space for turning motorists to yield to bicyclists and pedestrians. Research shows safety benefits at locations where bicycle crossings are offset from the motorist travelway at a distance of between 6 feet and 16.5 feet. This offset:

- a. improves a motorist's view of approaching bicyclists and pedestrians by reducing the need for motorists to scan behind them,
 - b. creates space for a motorist to yield to bicyclists and pedestrians without blocking traffic approaching from the rear (for right turns) or the side (for left turns across two-way streets), and
 - c. provides more time for all users to react to each other and negotiate the crossing.
- 5) A *Pedestrian Refuge* is a space within the street buffer where pedestrians can wait between the bikeway and general-purpose travel lanes. This is not necessary for protected intersections for sidepaths.
- 6) *Crossings and Markings* increase visibility of crossing bicyclists and pedestrians and clarify where pedestrians and bicyclists should cross the street.
- 7) *Signalization* is an approach to separate bicyclists/pedestrians and motor vehicles in time either by providing a bicycle-only signal (if appropriate) or allowing bicyclists to cross the street using the pedestrian signal. Providing bicyclists separate signal phases from motorists can reduce conflict between these modes.

Figure 17: A proposed protected intersection included in the Amherst Avenue Separated Bike Lane project

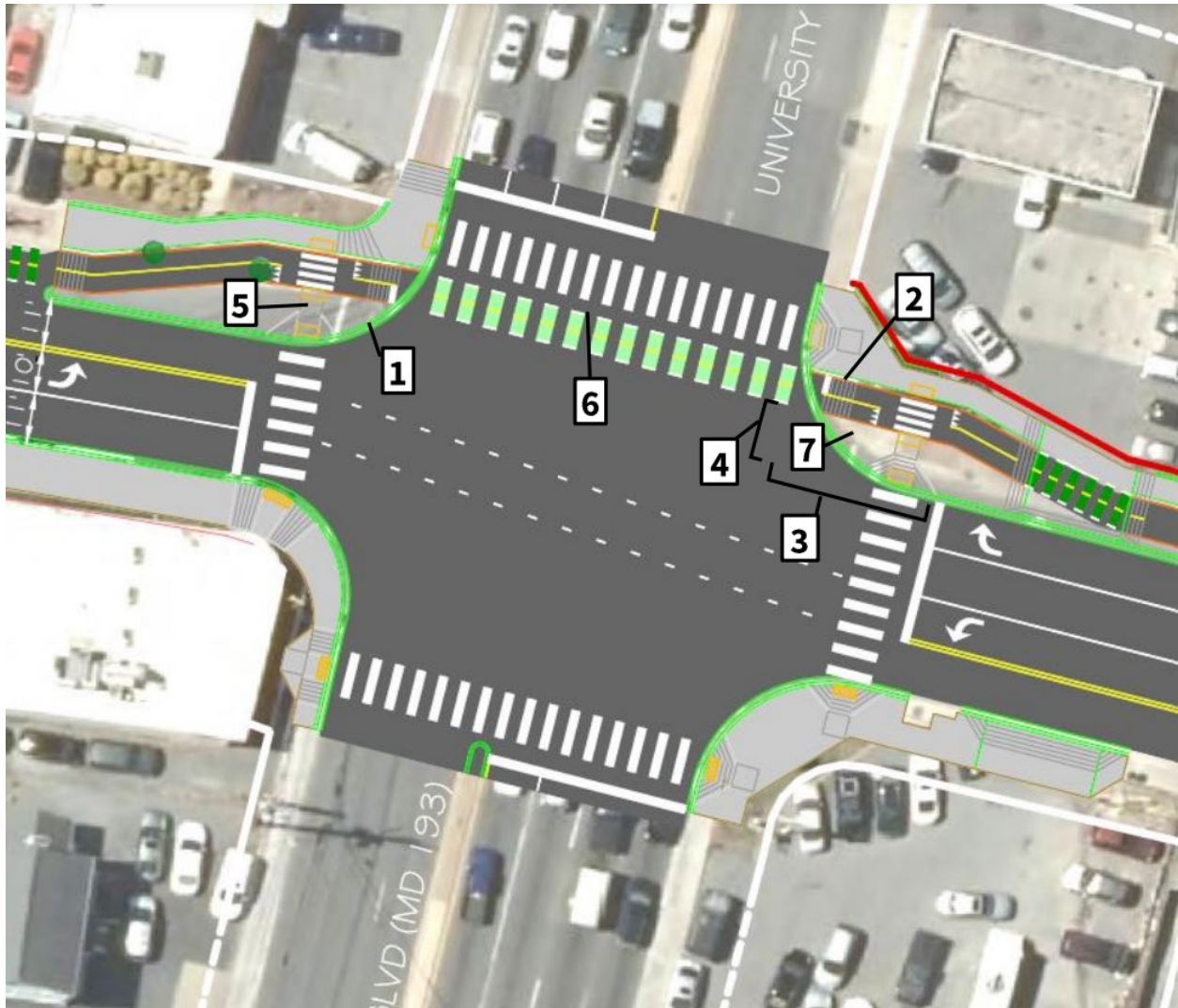

Recommendation: Smooth abrupt shifts in the sidepath alignment at Stations:

- | | | | |
|----|-------|----|-------|
| a. | 4+50 | d. | 28+00 |
| b. | 6+50 | e. | 77+00 |
| c. | 23+00 | f. | 85+00 |

There are several locations where the sidepath shifts horizontally in a manner that may be unsafe for users, particularly bicyclists. Figure 19 identifies one such location. The *Bicycle Master Plan* Bicycle Facility Design Toolkit indicates that the maximum “lateral taper” or horizontal shift should be at a 3:1 ratio or one foot horizontal for every three feet along the sidepath. The project team should ensure that all changes in horizontal sidepath alignment are not more aggressive than 3:1.

Figure 18: Abrupt Sidepath Shift East of Sequoyah Elementary School

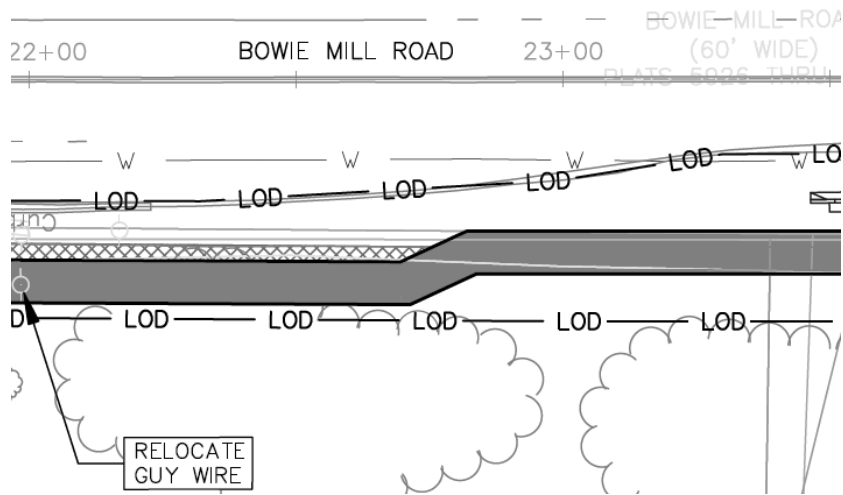

Recommendation: Extend the Bowie Mill Road sidepath to the pedestrian crossing at Olney-Laytonsville Road so that it connects with the existing sidepath along the north side of Olney-Laytonsville Road.

As currently designed, the proposed sidepath ends at the corner of Bowie Mill Road and Olney-Laytonsville Road as shown in Figure 20. Bicyclists would want to cross Olney-Laytonsville Road to use the sidepath along its north side (the dashed red path in the figure below) will have to use a 25-foot-long section of sidewalk to access the crossing, creating a potential pinch point for users. To mitigate this conflict, the proposed project should be extended to this protected crossing location at sidepath width.

Figure 19: Northern Sidepath Terminus

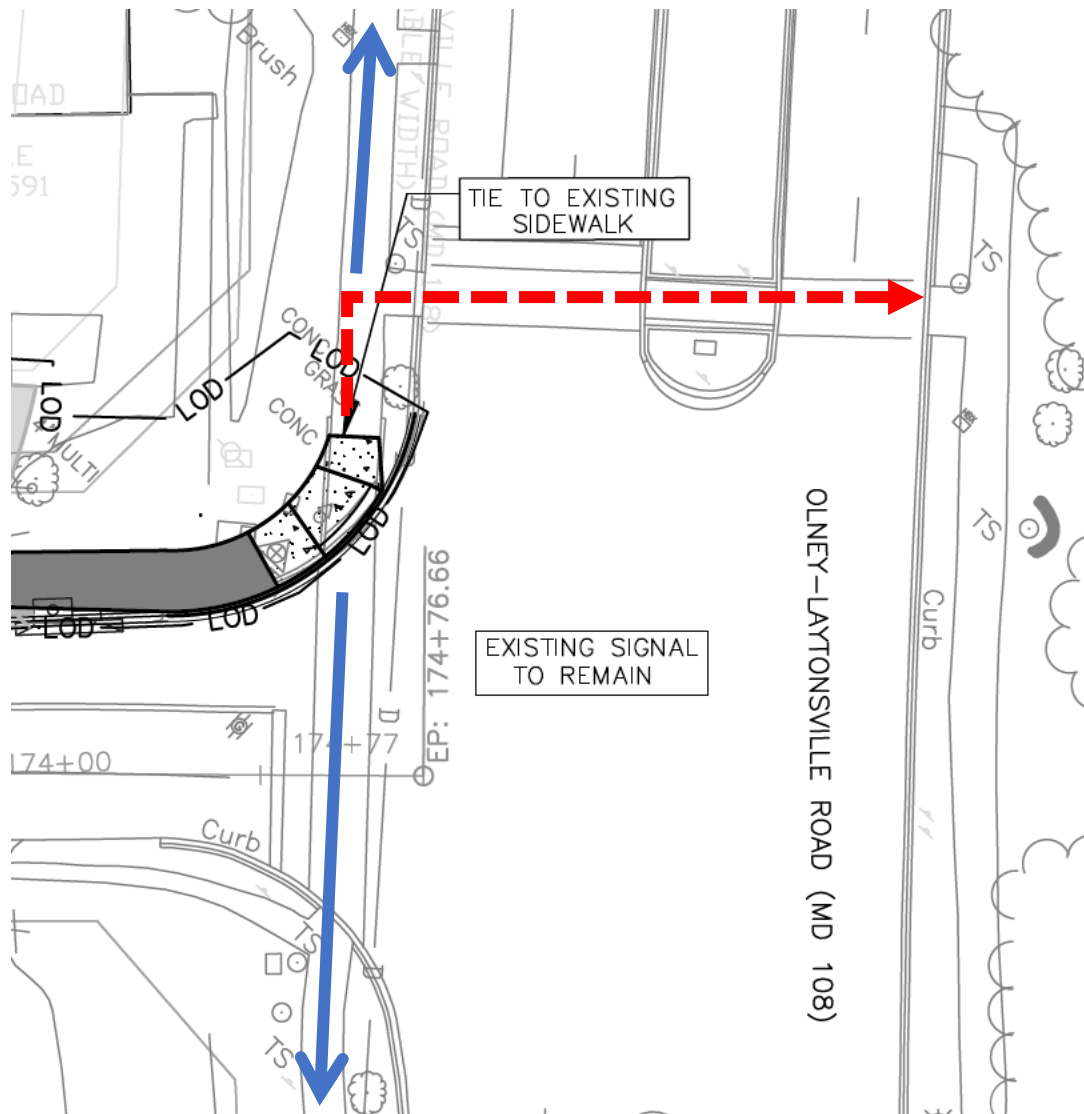

Recommendation: Explore opportunities to provide a wider sidepath and street buffer between the sidepath and Bowie Mill Road between Briars Road and Olney-Laytonsville Road.

Between Briars Road and Olney-Laytonsville Road, the sidepath narrows from the standard ten feet for areas outside of Special Protection Areas to eight feet, and has a one to two-foot-wide street buffer, as shown in Figure 20. Reducing the width of the sidepath and the street buffer as it nears Olney-Laytonsville Road Center is problematic, as Planning staff would expect more walking and bicycling at this end of the sidepath given the proximity to Olney Town Center. At the same time, a wider street buffer is preferred to minimize the likelihood of bicyclists or pedestrians unintentionally entering the roadway. The default street buffer width for this street type (Area Connector) will be six

feet in the coming update to the CSDG. Further project design should investigate widening the sidepath and street buffer, with a preference for a wider street buffer if both are not possible.

Figure 20: Narrow Sidepath with Minimal Buffer

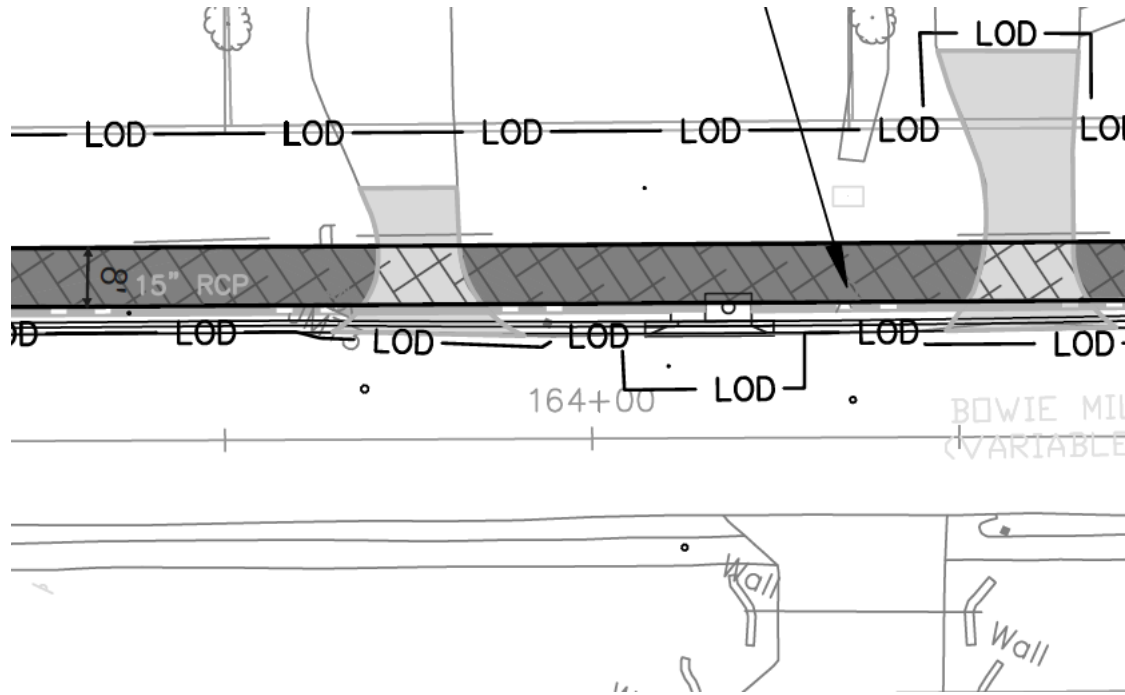

Recommendation: Develop a wayfinding plan using the bikeway branding signage standards.

Montgomery Planning, in consultation with MCDOT, has completed a branding plan for the county's bikeway network. This brand includes a wayfinding component to help bicyclists navigate the bikeway network to reach local and regional destinations (Figure 22). A pilot effort with MCDOT in North Bethesda is nearing final design. MCDOT should develop and install wayfinding using the same standards as part of the Bowie Mill Bikeway project.

Figure 21: Example of Breezeway Directional Signage



Environmental Analysis and Findings

ENVIRONMENTAL GUIDELINES

The project conforms to the Planning Board-approved *Environmental Guidelines for Environmental Management of Development in Montgomery County*. The project area contains environmental buffers, streams, and other sensitive features. The project is within the Upper Rock Creek watershed, a Use Class III designation. The project proposes 1.48 acres of forest removal and has impacts on approximately 0.25 acres (10,740 square feet) of Stream Valley Buffer (SVB). The environmental impacts have been minimized to the greatest extent possible, but are necessary and unavoidable to achieve the design standards of the proposed bikeway.

FOREST CONSERVATION

The project is exempt from Article II of Chapter 22A of the Montgomery County Code (“Forest Conservation Law”) and from the submission of a forest conservation plan. A forest conservation exemption request plan no. 42024017E was granted under Section 22A-5(e) as “a state or county highway project”. The exemption was confirmed on October 20, 2023.

While the project is exempt from Article II of the Forest Conservation Law, the applicant is still required under section 22A-9 of Chapter 22A of the County Code to:

- a) Minimize forest cutting, clearing, and loss of specimen trees to the extent possible while balancing other design, construction, and environmental standards. The constructing agency must make a reasonable effort to minimize the cutting or clearing of trees and other woody plants.
- b) If the forest to be cut or cleared for a County highway project equals or exceeds 20,000 square feet, the constructing agency must reforest a suitable area at the rate of one acre of reforestation for each acre of forest cleared.
- c) Mitigation for loss of specimen or champion trees. Mitigation amounts are based on the size and character of the tree.

The Applicant has minimized the limits of disturbance, minimizing the amount of forest clearing and impacts to large and specimen trees. However, the project still has impacts to forest and specimen trees.

The Applicant has provided a Tree Save Plan (“TSP”) to highlight forest loss/mitigation, tree save, and specimen tree mitigation. Even with minimizing the LOD and altering some design aspects there are some necessary and unavoidable impacts to forest. The project proposes to remove 1.48 acres (64,580 square feet) of forest which is above the forest clearing threshold of 0.46 acres (20,000 square feet) allowed under the Sec. 22A-9. Therefore, the Applicant is required to reforest a suitable area at a 2:1 rate for each acre of forest cleared. This results in a reforestation requirement of 2.96 acres which the applicant intends to meet by purchasing the appropriate reforestation credits in the DOT Damascus Snow Forest Bank.

In addition to forest loss, the TSP also proposes the removal of ten (10) specimen trees. Mitigation for the loss of these trees is being provided in the form of plantings of 78 2-inch caliper overstory trees within the Bowie Mill Road right-of-way.

Historic Preservation Analysis and Findings

No applicable comments.

Parks Analysis and Findings

PARKLAND IMPACTS

The Bowie Mill Road Bikeway project makes a critical connection to the North Branch Trail across Bowie Mill Road, enabling pedestrians and bicyclists to more safely access and utilize Montgomery Park's trails; better connecting a significant part of the 13-mile Mid-County Loop trail system. Currently the hard surface trail to the north of Bowie Mill Road (North Branch SVU4), does not have a marked crossing to connect to the natural surface trail south of Bowie Mill Road (North Branch SVU3) (Figure 23).

Figure 22: Existing Conditions of North Branch Trail at Bowie Mill Road; Map (left), Westbound View (middle), and Eastbound View (right)



This new connection (Figure 24) reroutes the hard surface trail in North Branch Stream Valley Park Unit 4 to a new marked crossing at Bluebell Lane to connect back to a new sidepath south of Bowie Mill Road and a new separated sidepath bridge over North Branch connecting back to the natural surface trail in North Branch Stream Valley Park Unit 3.

Figure 23: Proposed Reroute and Connection to North Branch Trail

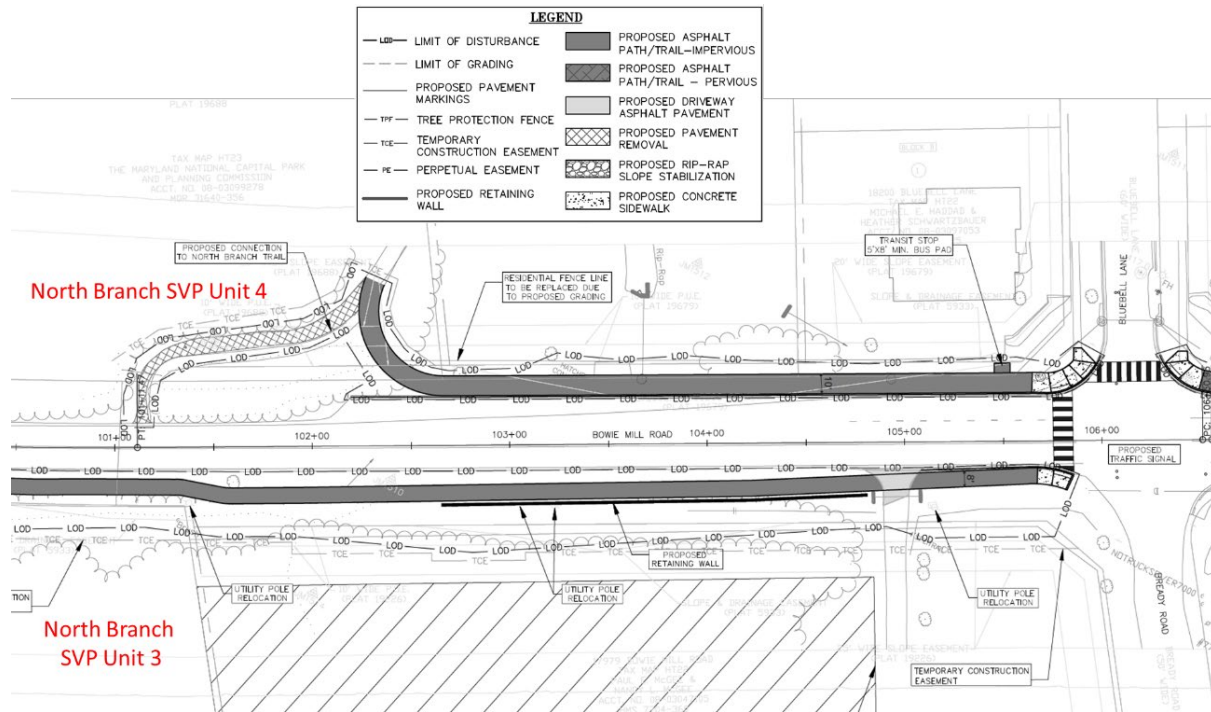

The proposed sidepath consists of an eight-foot-wide section along the length of parkland in North Branch Stream Valley Park Unit 3, a 10-foot-wide sidepath connecting to the hard surface trail in North Branch Stream Valley Park Unit 4, and an eight to nine-foot wide sidepath along Bowie Mill Local Park.

A 12-foot wide, 60-foot-long prefabricated sidepath bridge will be installed in North Branch Stream Valley Park Unit 3 on the south side of Bowie Mill Road. MCDOT and Montgomery Parks coordinated closely to ensure the sidepath bridge is being planned to avoid stream impacts. An eroded drainage along Bowie Mill Road in North Branch Stream Valley Park Unit 3 will be stabilized as part of the project (Figure 25).

Figure 24: North Branch SVP 3 at Bowie Mill Road Existing Conditions (left) and Proposed Sidewalk Bridge and Drainage Improvements (right)

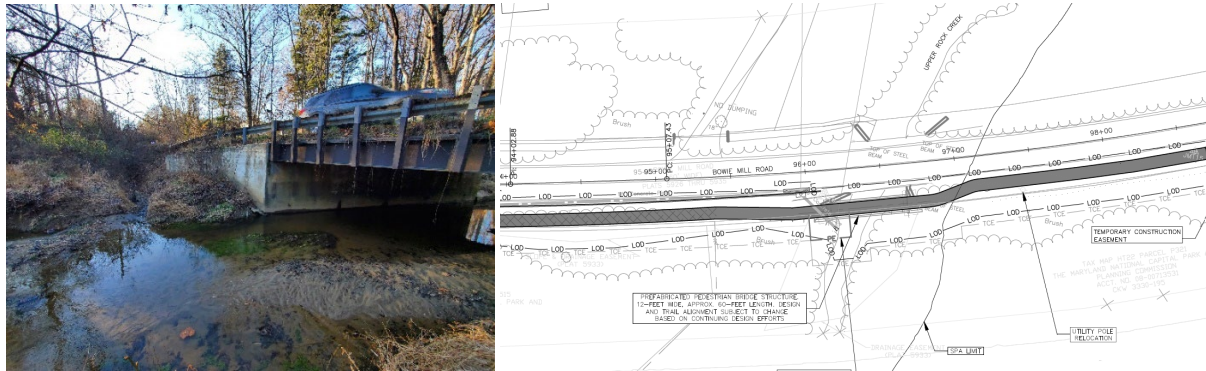

Minimal impacts are proposed in Bowie Mill Local Park. The existing sidewalk will be widened to an eight-to-nine-foot-wide sidepath and is separated from the park infrastructure by an existing stormwater pond embankment (Figure 26).

Figure 25: Existing Conditions along Bowie Mill Local Park



The current 70% design proposal will require the removal of eight trees (totaling 47.5-inches of trees) in North Branch Stream Valley Park Unit 3, and no trees are proposed for removal on parkland in North Branch Stream Valley Park Unit 4 or Bowie Mill Local Park.

Pedestrian lighting is intended to be included in the project scope, although the current design does not include a lighting plan. As the design advances, MCDOT will coordinate with Montgomery Parks on lighting impact avoidance and minimization measures.

The sidepath, bridge, and drainage improvements will require permanent impacts on parkland for the continued maintenance of the sidepath, bridge and drainage infrastructure and temporary impacts on parkland for the construction and access. The permanent impact will result in the creation of additional MCDOT right-of-way (through the granting at fair market value of a perpetual easement) consisting of 943 square feet in North Branch Stream Valley Park Unit 3. Temporary impacts for construction and access include approximately 3,800 square feet in North Branch Stream Valley Park Unit 4, 6,450 square feet in North Branch Stream Valley Park Unit 3, and 4,300 square feet in Bowie Mill Local Park.

Recommendation: MCDOT will continue to coordinate with Montgomery Parks on the design of the sidepath and other elements including lighting, user safety elements, drainage improvements, and natural resource protection and mitigation.

PARK CONSTRUCTION PERMIT

Recommendation: Construction plans must be submitted to the M-NCPPC Montgomery Parks Department for review as part of the Park Construction Permit process to ensure that all work is performed in accordance with Montgomery Parks standard details, specifications, and policies. No work on parkland may occur until an approved Park Construction Permit is issued for the project.

MCDOT will be required to obtain a Park Construction Permit from M-NCPPC Montgomery Parks prior to commencement of any construction activities on parkland. Plans submitted for Park Construction Permit review must include existing topography, utilities, and identify and locate all trees (with size and species) larger than 6-inch DBH and greater within 25 feet of the proposed Limit of Disturbance (LOD) on park property.

Recommendation: Mitigation for impacts to Montgomery Parks trees (with a 6-inch DBH or greater) damaged or removed, shall either be (1) replacement planting on parkland at a rate of one inch to one inch diameter or (2) a monetary per inch caliper basis at the rate of \$100/diameter inch, to be paid to Montgomery Parks prior to completion of construction.

Tree impacts will be determined by an M-NCPPC forester prior to construction based on the Final Design. During Park Construction Permit Review, Montgomery Parks staff will work with MCDOT to minimize impacts to parkland to the greatest extent possible and avoid all critical resources identified.

RIGHT-OF-WAY

Recommendation: Any approved Commission parkland such as North Creek Stream Valley Unit 3 to be added to the Montgomery County Department of Transportation Road right-of-way (ROW) will be transferred to the County, as appropriate, via perpetual easement. The Commission must be paid the fair market value of the perpetual easement prior to the issuance of a Park Construction Permit.

The permanent impact will result in the creation of additional MCDOT right-of-way totaling 943 square feet (through the granting at fair market value of a perpetual easement) from North Branch Stream Valley Park Unit 3 (Figure 27).

Figure 26: Area of Perpetual Easement for MCDOT Right-of-Way at North Branch SVP 3

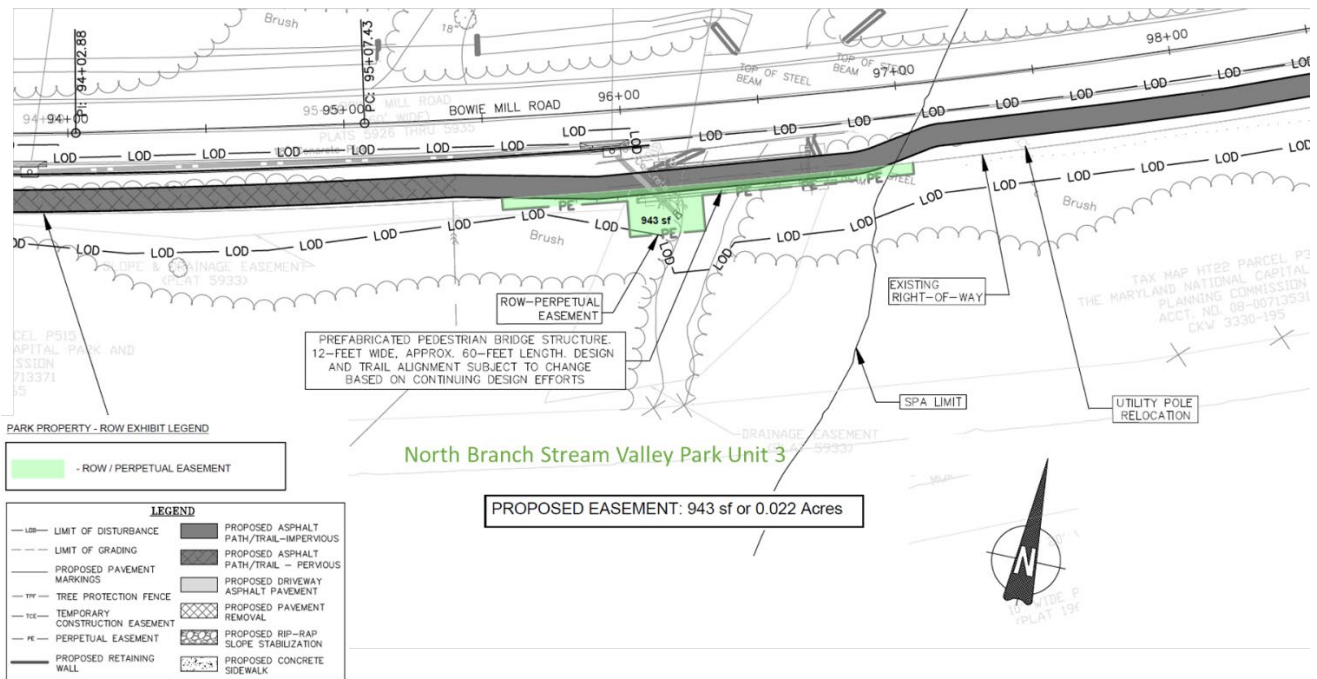

Recommendation: MCDOT and Montgomery Parks will continue to coordinate on a Memorandum of Understanding (MOU) at Bowie Mill Local Park regarding access and maintenance of the portion of the sidepath and lighting on parkland, which must be agreed to and finalized before the issuance of a Park Construction Permit.

Along the frontage of Bowie Mill Local Park, the sidepath and lighting will be located on park property. A Memorandum of Understanding (MOU) will be utilized at Bowie Mill Local Park and no perpetual easement will be granted (Figure 28). The MOU will establish the agreed upon maintenance responsibilities between MCDOT and Montgomery Parks in the shared maintenance area on parkland,

which will include approximately 3,390 square feet of parkland. MCDOT will be responsible for the maintenance of the sidepath and lighting.

Figure 27: Area of Shared Maintenance under Memorandum of Understanding within Bowie Mill Local Park

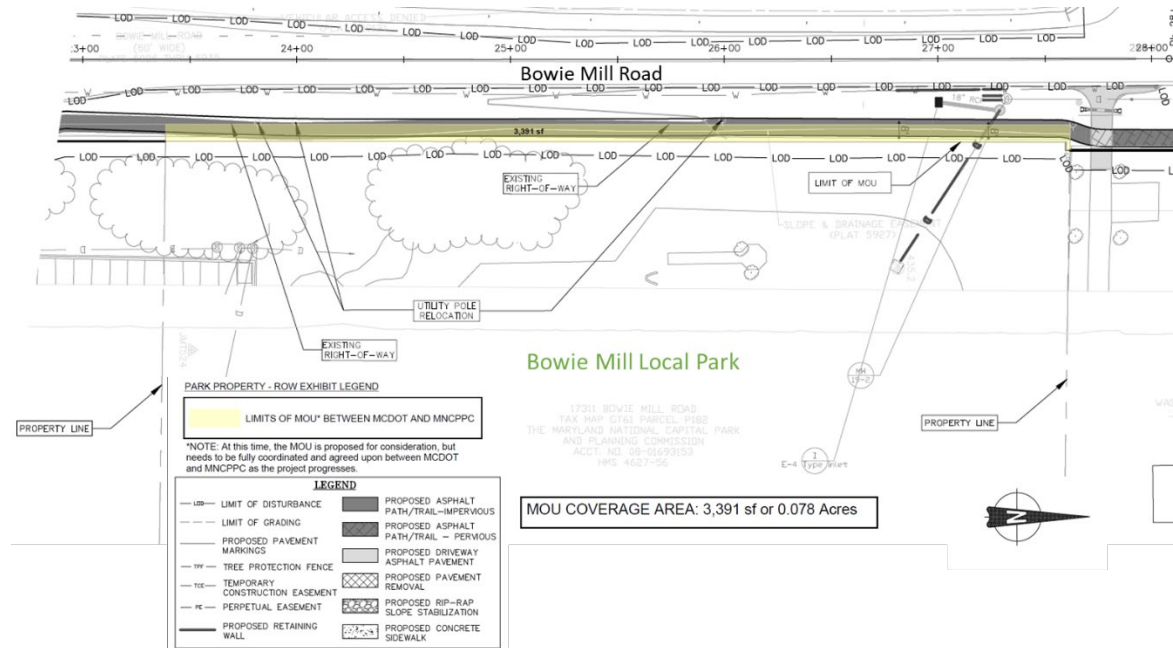

SECTION 6 – SPECIAL PROTECTION AREA WATER QUALITY PLAN

The Application satisfies all of the applicable requirements of Chapter 19 of the Montgomery County Code, the requirements of the Upper Rock Creek Overlay Zone, and the Environmental Guidelines, as discussed below.

Approximately 1.84 miles, about 55%, of this project is located within the Upper Rock Creek Special Protection Area (SPA) and the Upper Rock Creek Overlay Zone. As such, it is required to obtain approval of a water quality plan under section 19-62(b) of the Montgomery County Code.

As part of the requirements of the Special Protection Area law, a SPA Water Quality Plan should be reviewed in conjunction with a Mandatory Referral. Under Section 19-65 of the Montgomery County Code, the Montgomery County Department of Permitting Services (MCDPS) and the Planning Board have different responsibilities in the review of a Water Quality Plan. MCDPS has reviewed and conditionally approved the elements of the Water Quality Plan under its purview. The Planning Board's responsibility is to determine if SPA forest conservation and planning requirements, environmental buffer protection, and limits on impervious surfaces have been satisfied.

MCDPS and MCDEP Special Protection Area Review Elements

In a letter dated January 22, 2020, MCDPS found that elements of the SPA Preliminary/Final Water Quality Plan under its purview were acceptable (Attachment C).

Per the MCDPS Preliminary/Final Water Quality Plan memorandum, the required goals will be met with bio-swales, microbio-retention, and pervious pavement. Sediment and erosion control measures will be reviewed by MCDPS during the detailed sediment control/stormwater management plan stage. The Applicant will pay a stream monitoring fee to MCDPS due at time of detailed sediment control plan submittal and an SPA Best Management Practices monitoring fee to MCDPS due at time of as-built submittal.

Planning Board Special Protection Area Review Elements

What follows is an analysis of the Planning Board's responsibilities in the review of the Preliminary/Final Water Quality Plan.

Staff recommends Planning Board approval of the elements of the SPA Water Quality Plan under its purview.

1) **Priority Forest Conservation Areas**

The Application meets the requirements of Chapter 22A of the Montgomery County Forest Conservation Law. A Forest Conservation Exemption Plan, Plan No. 42024017E, was confirmed on October 20, 2023. This confirmation required that a Tree Save Plan – required under

Section 22A-9 of the Forest Conservation Law – be submitted with the Mandatory Referral application because more than 20,000 square feet of forest is proposed to be removed.

A Tree Save Plan was submitted with this application. The project proposes to remove 1.48 acres (64,580 square feet) of forest, which is above the forest-clearing threshold of 0.46 acres (20,000 square feet) allowed under Section 22A-9. Therefore, the Applicant is required to reforest a suitable area at a 2:1 rate for each acre of forest cleared. This results in a reforestation requirement of 2.96 acres which the Applicant intends to meet by purchasing the appropriate reforestation credits in the MCDOT Damascus Snow Forest Bank.

Condition of Approval: The Applicant must schedule the required site inspections by M-NCPPC Forest Conservation Inspection Staff per Section 22A.00.01.10 of the Forest Conservation Regulations.

Condition of Approval: The Applicant must comply with all tree protection and tree save measures shown on the approved Tree Save Plan. Tree save measures not specified on the Tree Save Plan may be required by the M-NCPPC Forest Conservation Inspection Staff.

Condition of Approval: Before the start of any demolition, clearing, grading or construction for this project, whichever comes first, the Applicant must record an M-NCPPC approved Certificate of Compliance in an M-NCPPC approved off-site forest bank to satisfy the reforestation requirement for a total of 2.96 acres of mitigation credit. The off-site requirement may be met by making a fee-in-lieu payment, subject to staff approval, if forest mitigation bank credits are not available at any bank.

2) **Environmental Buffer Protection**

The project passes through the stream valley buffer for the North Branch of the Rock Creek stream. There is unavoidable forest clearing within the stream buffer for the construction of the eight-foot bikeway. Typically, removal of forest within a stream valley buffer is not allowed, but preventing this forest removal would prevent the construction of the bikeway. Under Section VI.D of the Environmental Guidelines, an exception to the forest removal prohibition can be allowed in this case, given that the bikeway addresses planning and safety issues for the general public. The forest removed will be mitigated by purchasing the appropriate credits at a 2:1 rate in an off-site forest bank.

3) **Impervious Surfaces**

A main goal for development within all SPAs is to minimize impervious surfaces. Impervious surface restrictions for development projects in the Upper Rock Creek SPA are set forth in the Upper Rock Creek Overlay Zone. As per Chapter 59, Section 4.9.21, the maximum total

impervious surface area for any development is limited to ten percent. However, public projects are not limited by this requirement as set forth in Section 4.9.21.B.2, but are required to minimize imperviousness:

2. All public projects must satisfy the provisions of the URC Overlay Zone, however, these provisions are not intended to preclude the development of public facilities. Such facilities must conform to the water quality plan submission and review requirements established in Chapter 19, Article V, and keep imperviousness to the minimum needed to accomplish the public purpose intended.

The Applicant has demonstrated compliance with the impervious surface requirement by reducing the width of the proposed bikeway from the *Bicycle Master Plan*-recommended ten feet down to eight feet. This reduction in bikeway width for the total length of 1.85 miles within the Special Protection Area resulted in a twenty percent reduction of project impervious surface from an initial total of 175,000 square feet down to 140,000 square feet.

Condition of Approval: The Limits of Disturbance (“LOD”) shown on the Final Sediment and Erosion Control Plan must be consistent with the LOD shown on the approved Tree Save Plan.

Condition of Approval: The Planning Board accepts the recommendations of the Montgomery County Department of Permitting Services (“MCDPS”) – Water Resources Section in its Combined Preliminary/Final Water Quality Plan letter dated January 22, 2020 and hereby incorporates them as conditions of the Water Quality Plan approval. The Applicant must comply with each of the recommendations as set forth in the letter, which may be amended by MCDPS – Water Resources Section provided that the amendments do not conflict with other conditions of the Water Quality Plan approval.

SECTION 7 – COMMUNITY OUTREACH

After staff accepted the Mandatory Referral for review, Montgomery Planning notified local civic and homeowners' associations and other interested parties of this proposal. As of the date of this report, Planning staff have received no comments from the public about this project.

Most recently, the project team conducted a public workshop at Sequoyah Elementary School on May 3, 2018. Prior to this mandatory referral, the project has received letters of support from the Greater Olney Civic Association and the Washington Area Bicyclists Association.

SECTION 8 – CONCLUSION

Staff recommends transmittal of comments to the Montgomery County Department of Transportation.

Staff recommends approval of the Tree Save Plan and the Preliminary/Final Water Quality Plan with conditions.

SECTION 9 – ATTACHMENTS

Attachment A: Corridor Engineering Drawings

Attachment B: Montgomery Planning Protected Intersection Checklist

Attachment C: MCDPS Preliminary/Final Water Quality Plan Approval